

EE 42/100
Lecture 19: AC Power

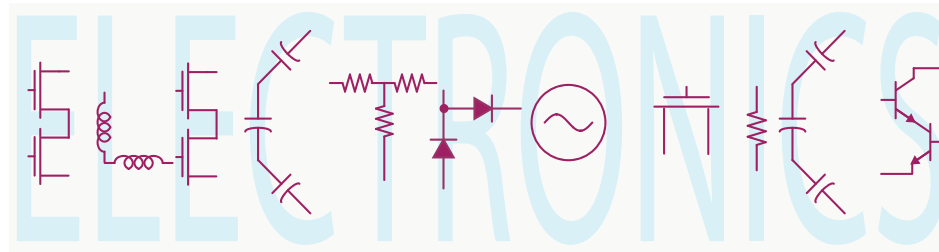

Rev A 3/31/2012 (3:55 PM)

Prof. Ali M. Niknejad

University of California, Berkeley

Copyright © 2012 by Ali M. Niknejad

Power

- Recall that the instantaneous power flow into a component is given by

$$p(t) = v(t)i(t)$$

≥ 0 DISS
 ≤ 0 SUPPLYING

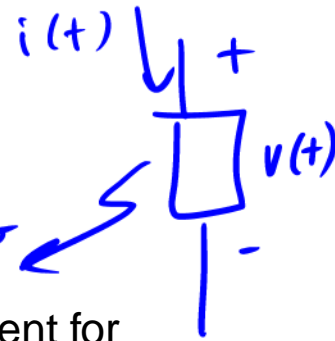

- This expression can be used to calculate the power flow into any component for arbitrary current/voltage waveforms.
- If we suppose that the current (voltage) is sinusoidal, then for linear components we know that the voltage (current) will also be sinusoidal, at the same frequency but possibly with a phase shift.

- The instantaneous power flow into a linear element is therefore given by

$$p(t) = V_{amp} \cos(\omega t) I_{amp} \cos(\omega t + \phi_{vi})$$

PHASE SHIFT

SAME FREQ

- We can simplify this expression if we use the following identity

$$\cos(a + b) = \cos(a) \cos(b) - \sin(a) \sin(b)$$

PF ~ 1

PF ~ 0

so

$$\cos(\omega t + \phi_{vi}) = \cos(\omega t) \cos(\phi_{vi}) - \sin(\omega t) \sin(\phi_{vi})$$

IN PHASE
 ω / VOLTAGE

90° out of PHASE

P real

IMAGINARY / REAC.

Trig Identities Galore!

- So if we expand the multiplication of current and voltage, we have

HAS DC COMPONENT

$$\cos(\omega t) \cdot (\cos(\omega t) \cos(\phi_{vi}) - \sin(\omega t) \sin(\phi_{vi}))$$

INTEGRATES TO ZERO OVER R

$$T = \frac{1}{f} = \frac{2\pi}{\omega}$$

$$= \cos^2(\omega t) \cos(\phi_{vi}) - \cos(\omega t) \sin(\omega t) \sin(\phi_{vi})$$

- Since $\sin(2x) = 2 \sin(x) \cos(x)$ and $\cos^2 x = \frac{1}{2} (1 + \cos(2x))$ we can write

2ND HARM

DC COMP ← 2ND HARM

$$= \frac{1}{2} (1 + \cos(2\omega t)) \cos(\phi_{vi}) - \sin(2\omega t) \sin(\phi_{vi})$$

- Which can be simplified to

$$= \frac{1}{2} \cos(\phi_{vi}) + \frac{1}{2} \cos(2\omega t + \phi_{vi})$$

- Which means that the power flow can be completed by

ALL NEW

$$p(t) = \frac{V_{amp} I_{amp}}{2} \cos(\phi_{vi}) + \frac{V_{amp} I_{amp}}{2} \cos(2\omega t + \phi_{vi})$$

LIKE DC

EXTRA

EXTRA!

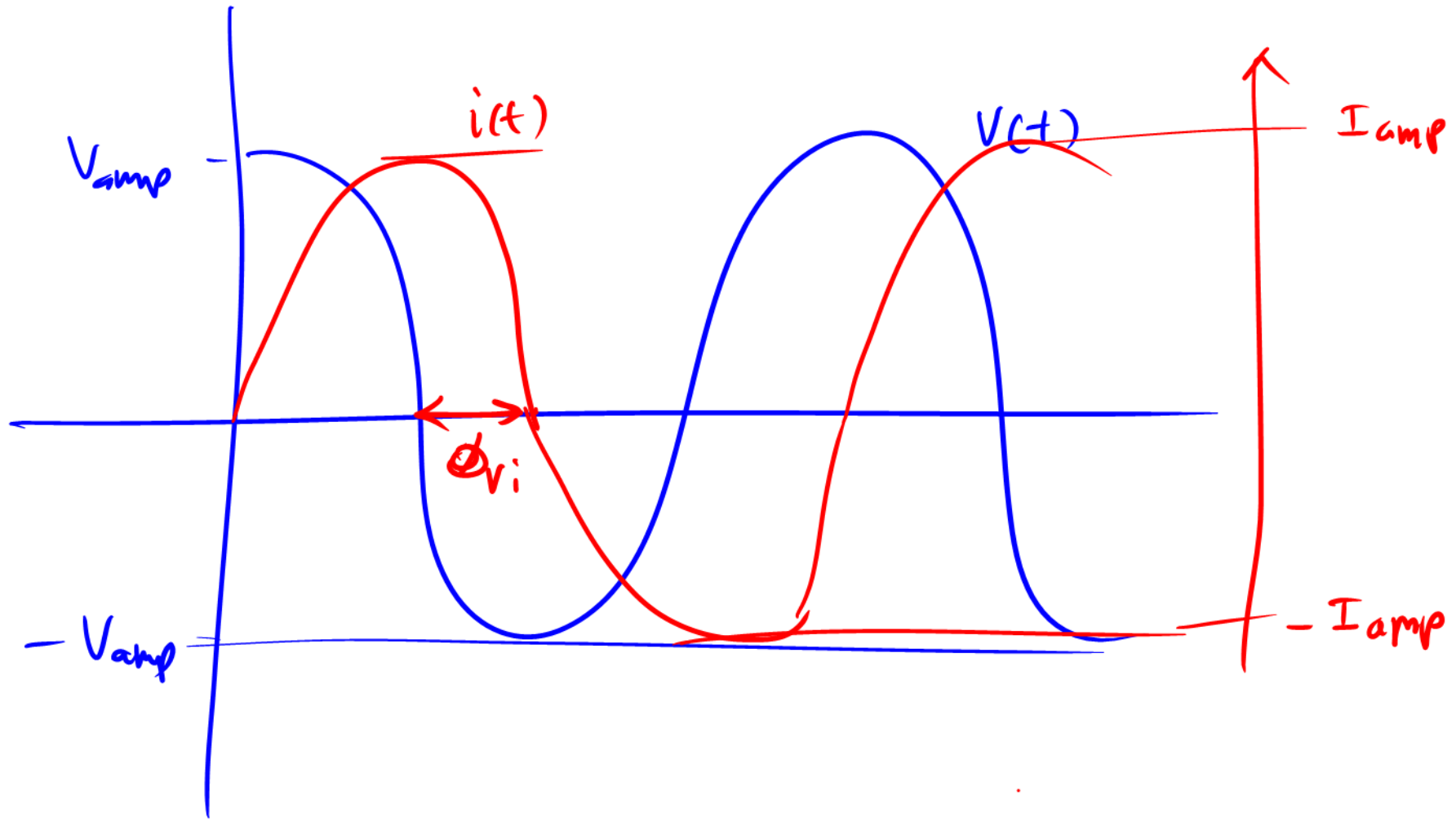

Average Power

$$p(t) = \frac{V_{amp}I_{amp}}{2} \cos(\phi_{vi}) + \frac{V_{amp}I_{amp}}{2} \cos(2\omega t + \phi_{vi})$$

Handwritten red scribble

- In this expression, V_{amp} is the peak amplitude of the voltage, I_{amp} is the peak current amplitude, and ϕ_{vi} is the phase difference between current and voltage.
- The first term is constant whereas the second term is varying ! Note that the second term is varying at twice the frequency of the sinusoid.
- If we calculate the average power over one cycle, the second term vanishes since it's positive and negative in exactly the same amount

$$p_{av} = \frac{V_{amp}I_{amp}}{2} \cos(\phi_{vi})$$

$$\frac{1}{T} \int_0^T P(t) dt = P_{av} = \frac{V_{amp} I_{amp} \cos \phi_{vi}}{2} + \int_0^T \cos(2\omega t + \phi) dt$$



Power Factor

$$p_{av}(t) = \frac{V_{amp} I_{amp}}{2} \underbrace{\cos(\phi_{vi})}_{PF}$$

- The phase difference between the current and voltage is of utmost importance. Note that if the phase difference is zero (resistive load), then we maximize the average power.

$$p_{av}(t) = \frac{V_{amp} I_{amp}}{2}$$

- For any other load impedance, the power delivered is lower exactly by $\cos(\phi_{vi})$, which is known as the Power Factor (PF).

$$PF = \cos(\phi_{vi})$$

$PF = 0$ CAPACITIVE OR INDUCTIVE LOAD
 $|PF| = 1$ GOOD

RMS Quantities

- The expression for power can be written in the following form

$$p_{av}(t) = V_{rms} I_{rms} \cos(\phi_{vi})$$

$$V_{rms} \triangleq \frac{V_{amp}}{\sqrt{2}}$$

$$I_{rms} \triangleq \frac{I_{amp}}{\sqrt{2}}$$

- The term V_{rms} is the root mean square of the voltage waveform. In words, first square the waveform, then take it's mean (average), and then take the square root

$$V_{rms} = \sqrt{\frac{1}{T} \int_0^T V_{amp}^2 \cos^2(\omega t) dt}$$

s (points to the exponent 2 on V_{amp})
m (points to the integral term)

$$V_{rms} = \sqrt{\frac{1}{T} \int_0^T V_{amp}^2 \frac{1}{2} (1 + \cos(2\omega t)) dt} = \frac{V_{amp}}{\sqrt{2}}$$

- In the power industry, people often speak of RMS quantities since calculating power with RMS quantities is more direct.
- So when we say that the power outlet is 120V, it's actually the RMS value. To get peak amplitude, you should multiply by $\sqrt{2}$

Power from Phasors

- Let us introduce the concept of “complex” power, or the product of the voltage phasor with the complex conjugate of the current phasor.

$$S = \frac{V \cdot I^*}{2}$$

← PHASOR ← PHASOR

- Alternatively, we can take the current phasor and multiply by the complex conjugate of the voltage phasor

$$S = \frac{I \cdot V^*}{2}$$

- As we shall see shortly, it does not matter which product we use. We can write this complex power as

$$S = \frac{|V| e^{j\phi_v} |I| e^{-j\phi_i}}{2} = \frac{|V||I|}{2} e^{j(\phi_v - \phi_i)}$$

← COMPLEX CONJ



- If we take the real part of the above quantity, we get

$$\Re(S) = \frac{|V||I|}{2} \cos(\phi_v - \phi_i)$$

- In other words, the average power is given by

$$P_{av} = \frac{1}{2} \Re(S)$$

$$S = \frac{V \cdot I^*}{2} = \frac{Z \cdot I \cdot I^*}{2}$$

$$= \frac{Z |I|^2}{2}$$

A circuit diagram showing a rectangular impedance element. The top terminal is marked with a '+' sign and the bottom terminal with a '-' sign. A vertical arrow labeled 'V' points downwards across the element. To the right of the element, the equation $V = Z \cdot I$ is written.

$$\text{Re}(S) = \frac{|I|^2}{2} \text{Re}(Z) = P_{av}$$

$$Z = R + j\omega C$$



EX 2

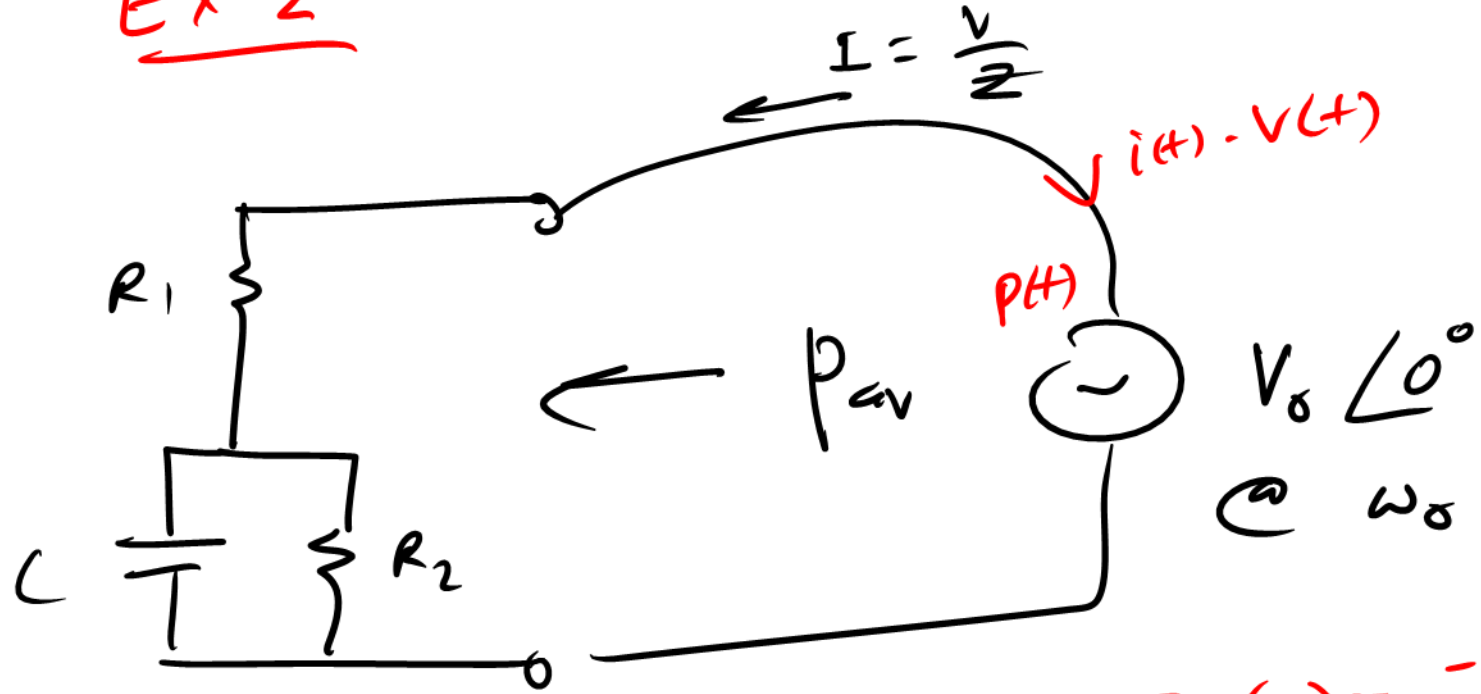

$$\begin{aligned}
 Z &= R_1 + R_2 \parallel \frac{1}{j\omega C} \\
 &= R_1 + \frac{R_2 \cdot \frac{1}{j\omega C}}{R_2 + \frac{1}{j\omega C}}
 \end{aligned}$$

$$= R_1 + \frac{R_2}{1 + j\omega R_2 C} = R_1 + \frac{R_2(1 - j\omega R_2 C)}{1 + \omega^2 (R_2 C)^2}$$

$$Re(Z) = R_1 + \frac{R_2}{1 + \omega^2 (R_2 C)^2}$$

$$Im(Z) = \frac{-\omega R_2 C}{1 + \omega^2 (R_2 C)^2}$$

$$Q = \frac{|I|^2 \cdot Im(Z)}{2}$$

POWER RELATION IN TERMS OF V

$$S = \frac{V \cdot I^*}{2} = \frac{V}{2} \left(\frac{V}{Z} \right)^*$$

$$= \frac{|V|^2}{2 Z^*} = \frac{|V|^2 Z}{2 |Z|^2}$$

$$P_{av} = \operatorname{Re}(S) = \frac{|V|^2}{2 |Z|^2} \operatorname{Re}(Z)$$

$$P_{dc} = \frac{V_{dc}^2}{R}$$

SUPPOSE $Z = R$

$$\frac{|V_{dc}|^2}{R^2} \cdot R \quad \checkmark$$

More Power to You!

- In terms of circuit impedance we have:

$$P = \frac{1}{2} \Re(I \cdot V^*) = \frac{1}{2} \Re\left(\frac{V}{Z} \cdot V^*\right) = \frac{|V|^2}{2} \Re(Z^{-1})$$

- Let's clear the inverse Z term by multiplying and dividing by the complex conjugate

$$P = \frac{|V|^2}{2} \Re\left(\frac{Z^*}{|Z|^2}\right) = \frac{|V|^2}{2|Z|^2} \Re(Z^*) = \frac{|V|^2}{2|Z|^2} \Re(Z)$$

- We can derive an analogous expression using admittance

$$P = \frac{1}{2} \Re(V \cdot I^*) = \frac{1}{2} \Re(Y^{-1} I \cdot I^*) = \frac{|I|^2}{2} \Re(Y^{-1})$$

$$P = \frac{|I|^2}{2|Y|^2} \Re(Y)$$

Reactive Power

2

- A very important result is that imaginary impedances do not dissipate any power on average

$$P_{av} = \frac{|V|^2}{2|Z|^2} \Re(Z) = 0$$

$$\frac{1}{T} \int_0^T z dt = \frac{1}{j\omega C}$$

- That's because these components (such as capacitors) can only store or supply energy, but they cannot dissipate energy. Nevertheless they draw power and return power to a generator, and so they need to be taken into account.
- The power draw of such components is known as *Reactive Power*
- From the complex power we have

$$S = \frac{V \cdot I^*}{2} = \frac{|I|^2 Z}{2} = \frac{|I|^2 (R + jX)}{2}$$

DIS (under R) IMAG. POWER (under X)

- The real part of S is therefore the power loss in the real part of the load impedance. The imaginary part of S is reactive power

$$Q = \Im(S) = \frac{|I|^2 X}{2}$$

REPRESENTS POWER FLOW w/ ZERO AV

$$S = P + jQ$$

↑
AV POWER
↑
REACTIVE POWER

Example Power Calculation

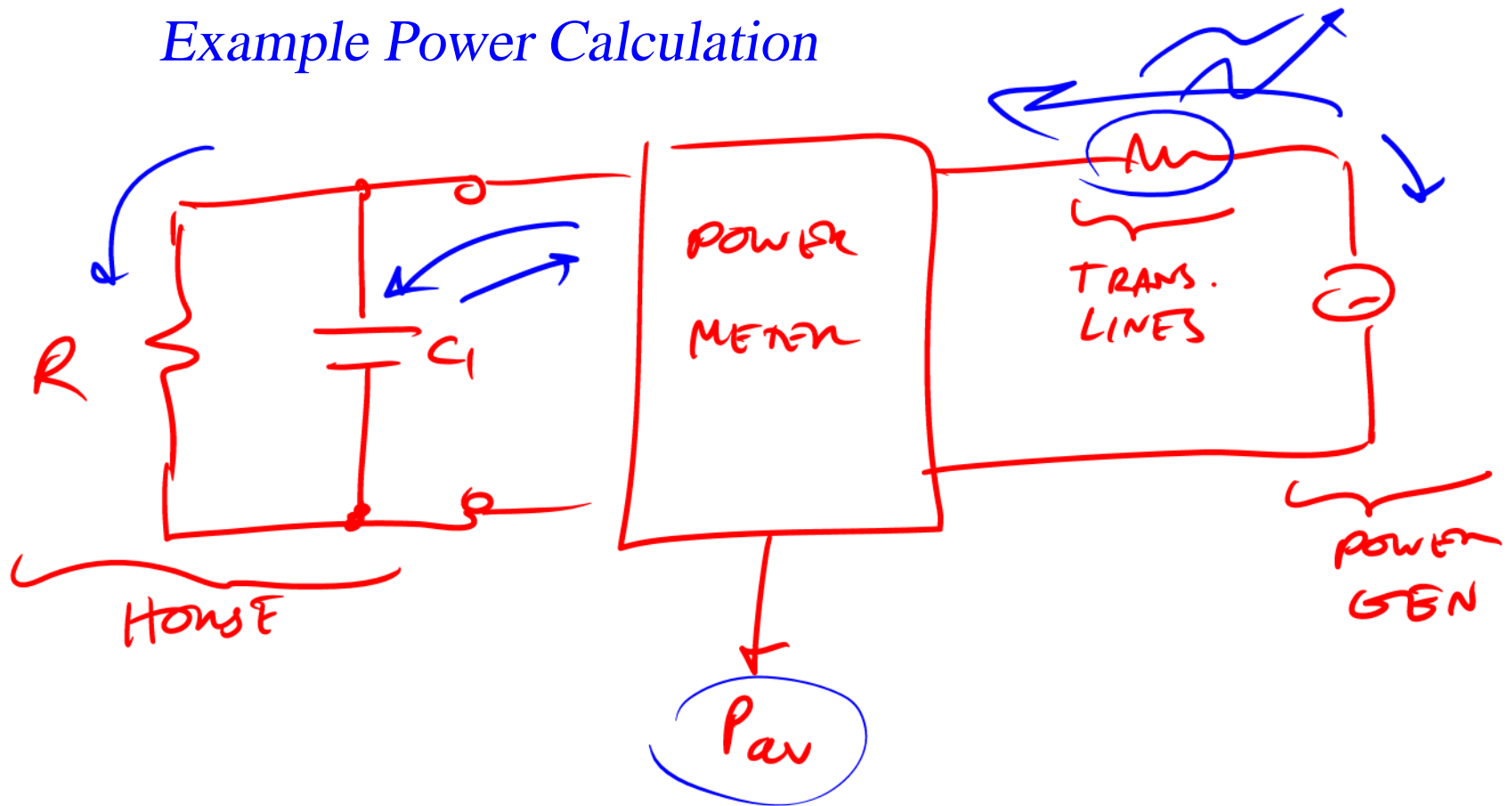

AC Power To Your Home

A

- In a typical US residential system, three wires come into the home, usually called “red” (R), “black” (B) and “white” (W), where the red and black wires are “hot” and the white is neutral, tied to earth ground.
- The hot wires are each 120Vrms AC with opposite polarity so that a total of 240Vrms can be derived between them. Most stuff runs on 120V so a normal outlet has ~~B~~ and W grounded and only R is hot.
- A 240V outlet, though, will be hot on both B and R, and W is the only grounded wire. So be careful and don't assume that B is always grounded.

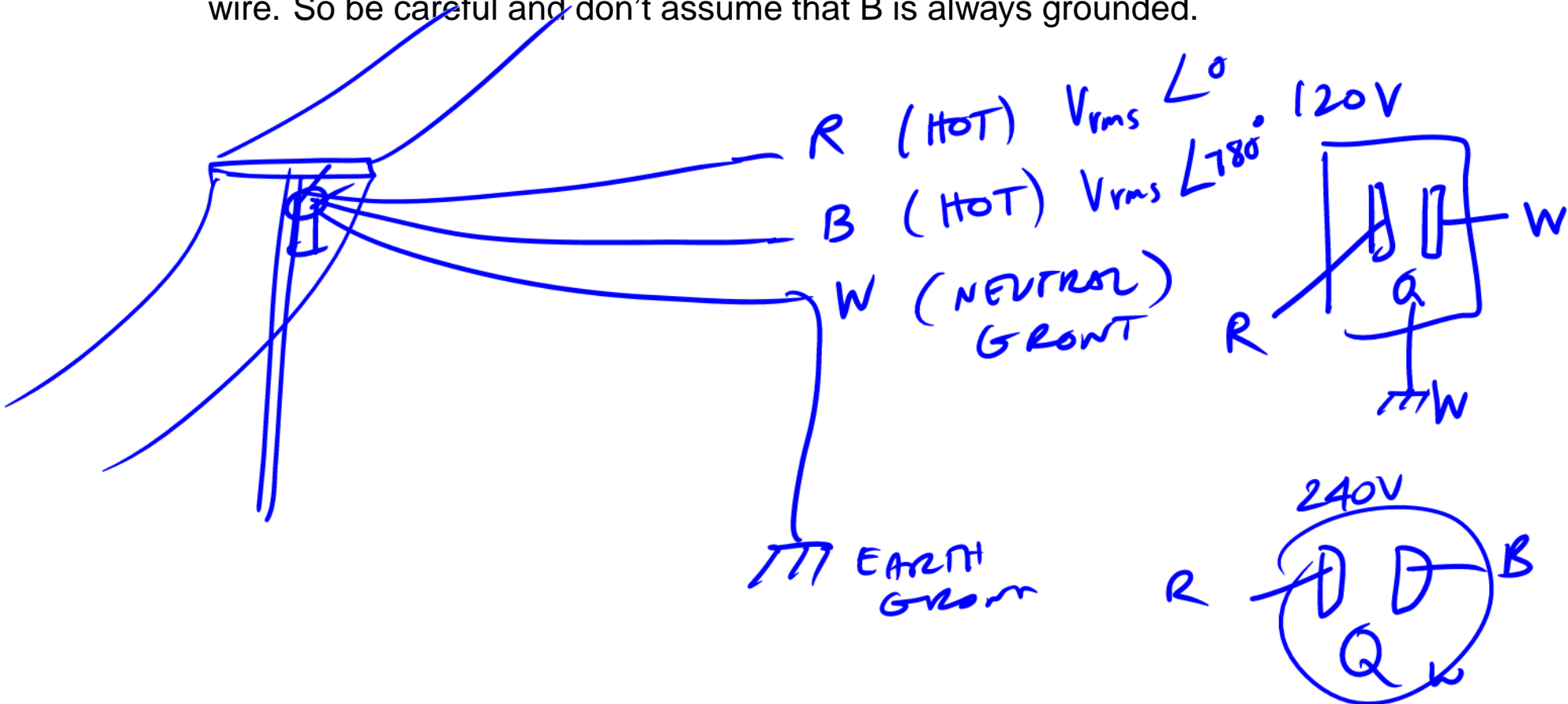

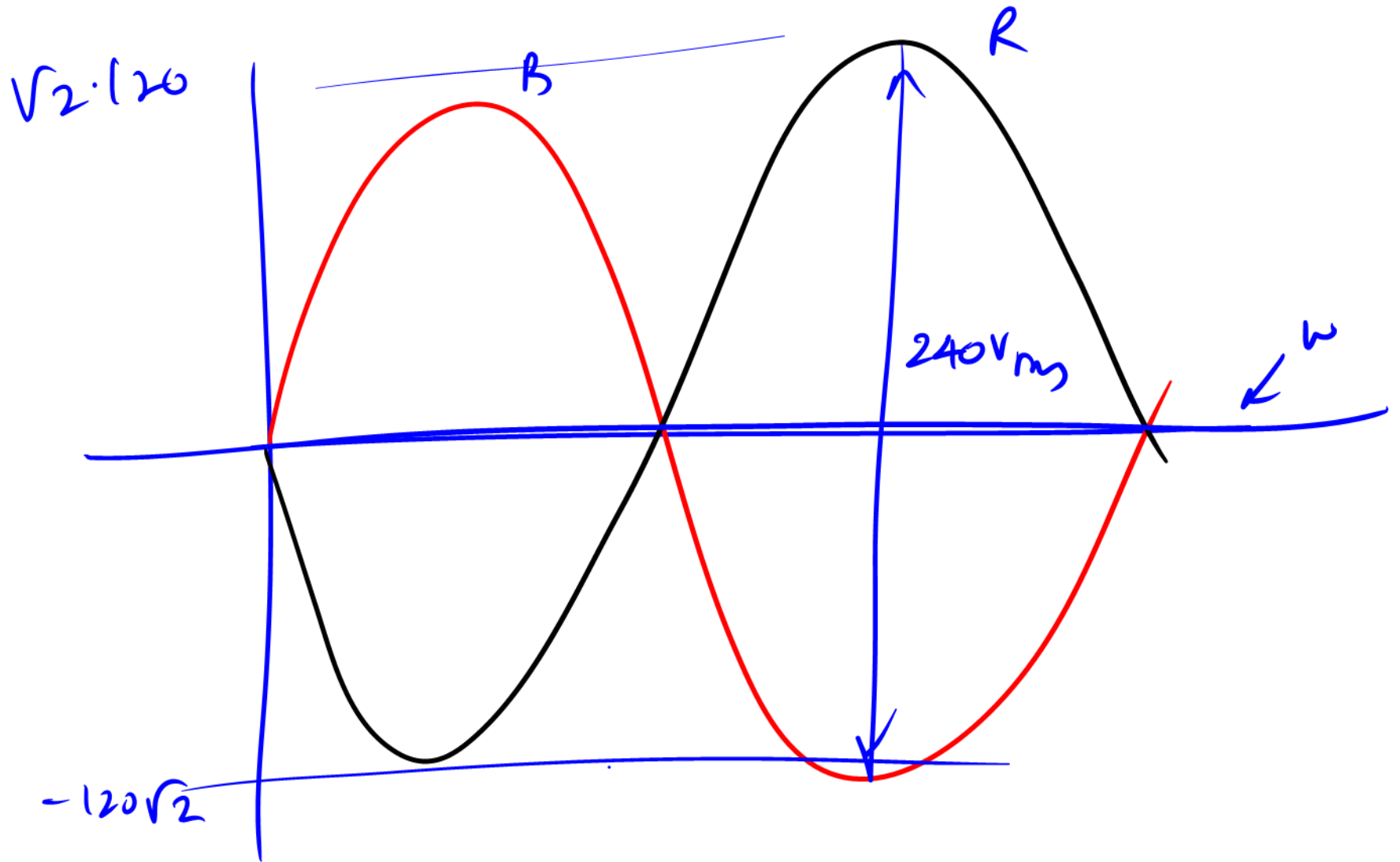

Electrical Safety

- Why 3 wires, with 2 grounds, on most outlets?
- The reason is that we use the G to ground the chassis of the electrical device, otherwise it could be at any potential, potentially at dangerous levels (especially if it's high up in the atmosphere where static charge build up can occur due to lightning or simply due to altitude).
- By grounding the chassis, we also have the additional benefit that if somehow there is a malfunction and a hot wire touches the chassis, creating a dangerous situation (if you touch the device you could get shocked), a large current would flow from the R to G
- A GFI, or Ground Fault Interrupt, is used to detect this condition and to break the circuit. The GFI works as follows. It examines the current in the R and W and if these currents are different, then it breaks the circuit. That's because all the return current should be flowing through W and not any other path (such as a person!).
- GFI is used commonly for outdoor outlets or outlets where there could be water (kitchen, bathroom), because a wet person makes much better contact to ground and to other circuitry (the resistance of the skin drops).

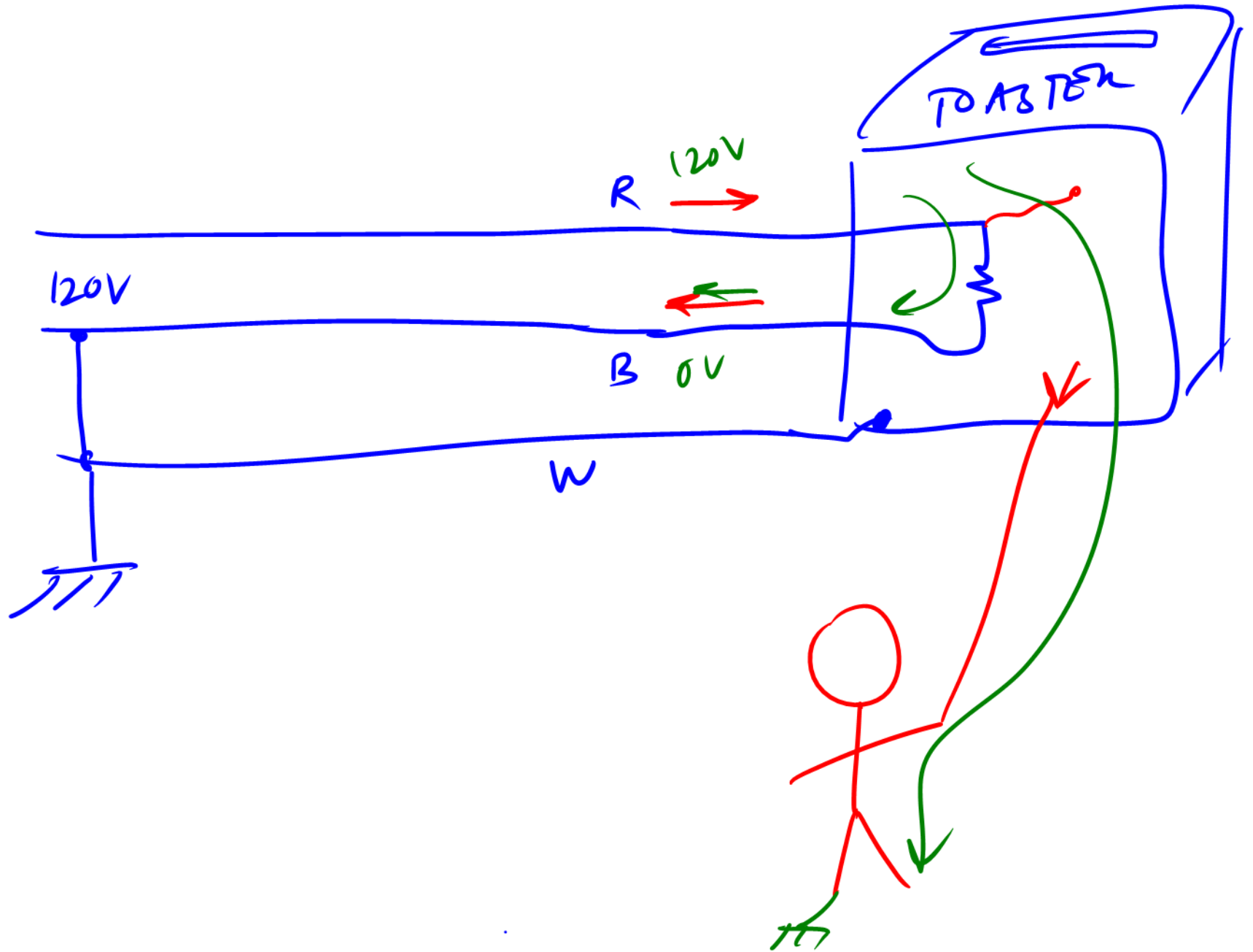

AC Power Transmission

- As we discussed early in this class, AC power is transmitted at a very high voltage to minimize transmission losses.
- A typical scenario might involve an AC generator at 18kV, a step-up to 345 kV for long range transmission, and then a step down to 45kV and then 4800V for commercial customers.
- There's a transformer on the pole near your house that steps this down to 240V/120V that we use.
- As you may know, the power is transmitted in three phases rather than a single phase. Why?

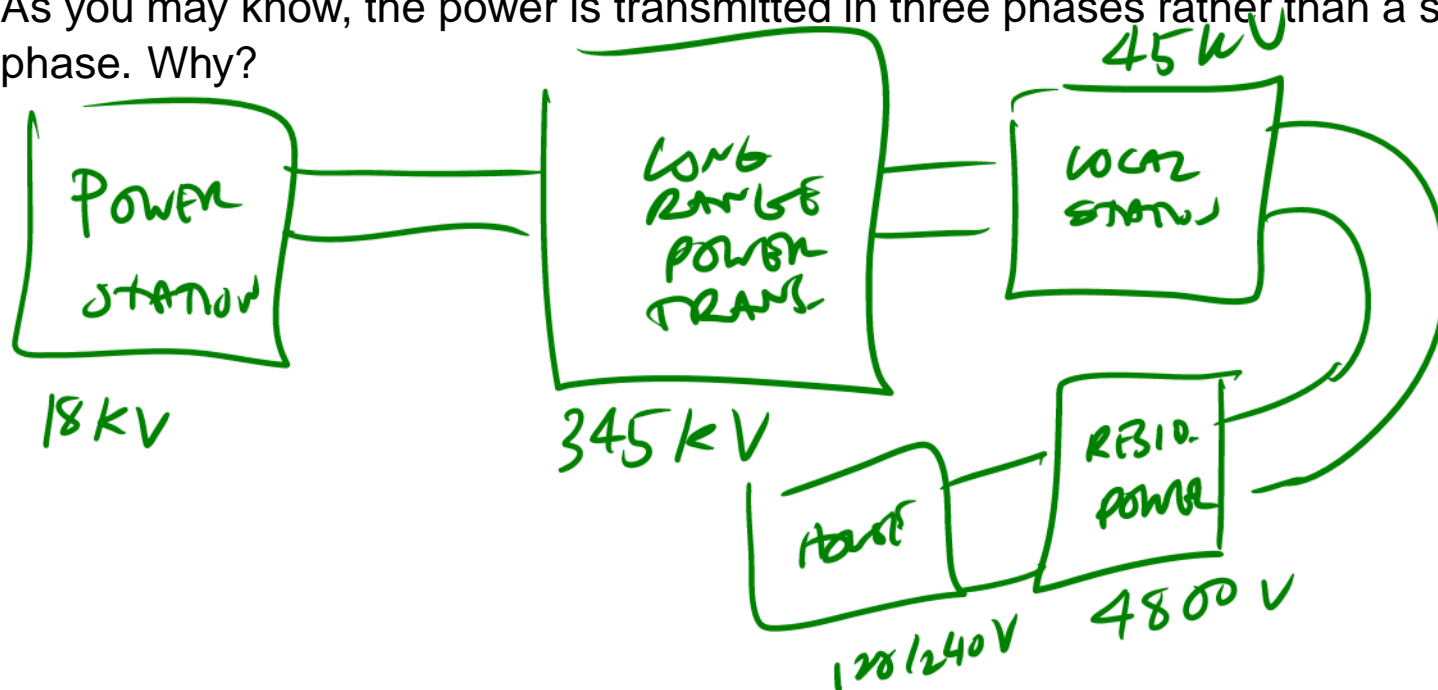

TRANSFORMERS

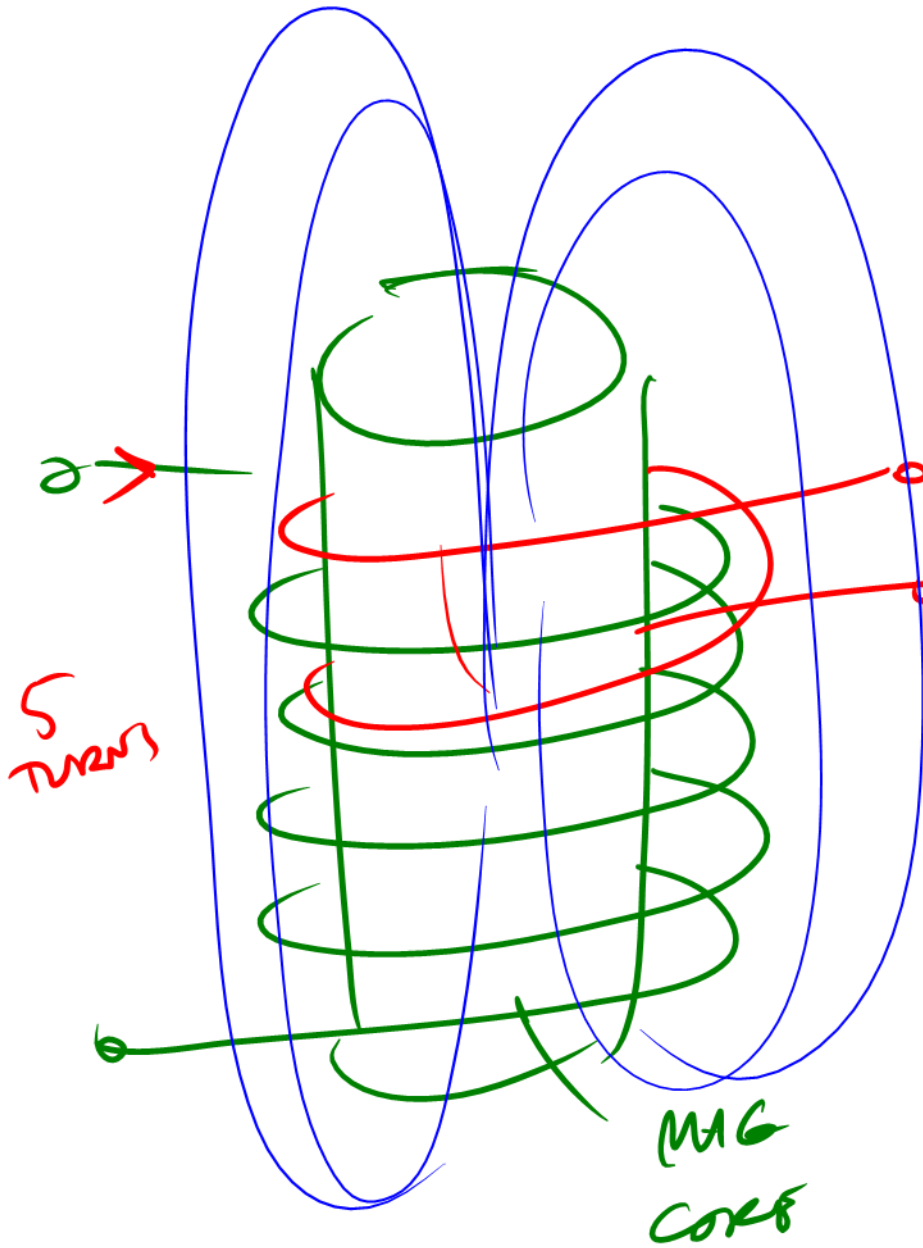

$$\frac{V_{out}}{V_{in}} \propto \frac{2}{5}$$

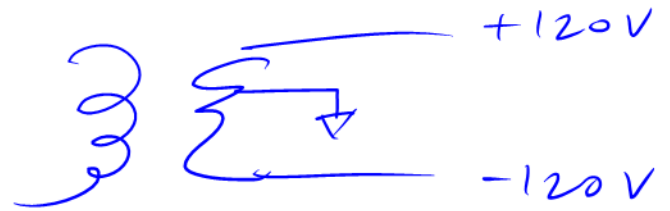

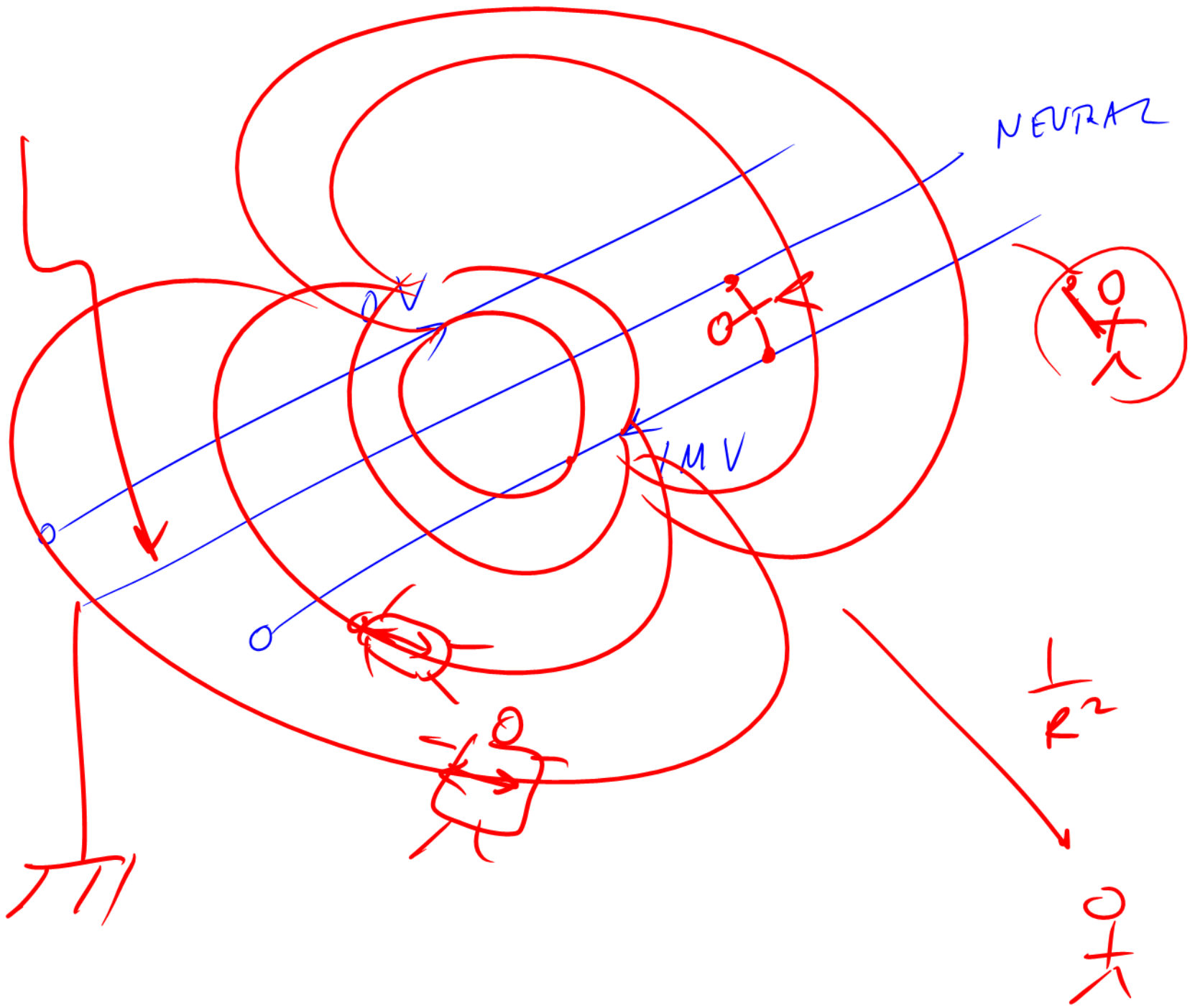

Three Phase Power Deliver

- In a three phase system, three wires are used where each wire carries a voltage of

$$V_a = |V_a| \angle 0^\circ$$

$$V_b = |V_b| \angle -120^\circ$$

$$V_c = |V_c| \angle -240^\circ$$

- Three phase power is used because it turns out that you can transmit more power with the same amount of cable and furthermore the power is not pulsating in nature.
- Let's calculate the instantaneous power delivered to three resistive loads on each line using $|V_a| = |V_b| = |V_c| = V$

$$p_a(t) = \frac{V^2}{R} (1 + \cos(2\omega t))$$

$$p_b(t) = \frac{V^2}{R} (1 + \cos(2\omega t - 120^\circ))$$

$$p_c(t) = \frac{V^2}{R} (1 + \cos(2\omega t - 240^\circ))$$

Three Phase Power

- If we sum these three powers, we have

$$p(t) = p_a(t) + p_b(t) + p_c(t) = \frac{3V^2}{R} + \frac{V^2}{R} (\cos(2\omega t) + \cos(2\omega t - 120^\circ) + \cos(2\omega t - 240^\circ))$$

$$p(t) = \frac{3V^2}{R}$$

- That's a constant power ! Unlike single phase AC, there's no pulsating component, which reduces wear and stress on generating equipment. It's like a V8 versus a single piston motor.