

*EECS 242*

*Scattering Parameters*

Prof. Niknejad

University of California, Berkeley

# Scattering Matrix

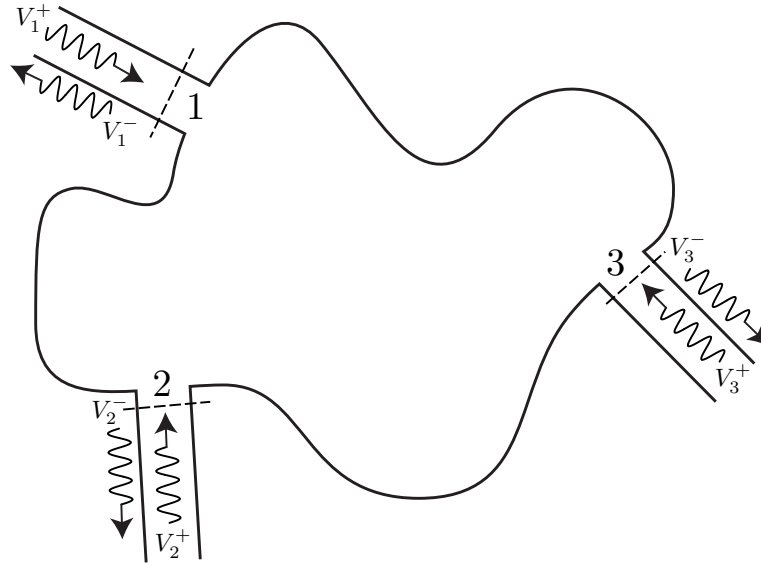

- Voltages and currents are difficult to measure directly at microwave freq.  $Z$  matrix requires “opens”, and it’s hard to create an ideal open (parasitic capacitance and radiation). Likewise, a  $Y$  matrix requires “shorts”, again ideal shorts are impossible at high frequency due to the finite inductance.
- Many active devices could oscillate under the open or short termination.
- $S$  parameters are easier to measure at high frequency. The measurement is direct and only involves measurement of relative quantities (such as the SWR or the location of the first minima relative to the load).
- It’s important to realize that although we associate  $S$  parameters with high frequency and wave propagation, the concept is valid for any frequency.

## Power Flow in an One-Port

- The concept of scattering parameters is very closely related to the concept of power flow. For this reason, we begin with the simple observation that the power flow into a one-port circuit can be written in the following form

$$P_{in} = P_{avs} - P_r$$

- where  $P_{avs}$  is the available power from the source. Unless otherwise stated, let us assume sinusoidal steady-state. If the source has a real resistance of  $Z_0$ , this is simply given by

$$P_{avs} = \frac{V_s^2}{8Z_0}$$

- Of course if the one-port is conjugately matched to the source, then it will draw the maximal available power from the source. Otherwise, the power  $P_{in}$  is always less than  $P_{avs}$ , which is reflected in our equation. In general,  $P_r$  represents the wasted or untapped power that one-port circuit is “reflecting” back to the source due to a mismatch. For passive circuits it’s clear that each term in the equation is positive and  $P_{in} \geq 0$ .

## Power Absorbed by One-Port

- The complex power absorbed by the one-port is given by

$$P_{in} = \frac{1}{2}(V_1 \cdot I_1^* + V_1^* \cdot I_1)$$

- which allows us to write

$$P_r = P_{avs} - P_{in} = \frac{V_s^2}{4Z_0} - \frac{1}{2}(V_1 I_1^* + V_1^* I_1)$$

- the factor of 4 instead of 8 is used since we are now dealing with complex power. The average power can be obtained by taking one half of the real component of the complex power. If the one-port has an input impedance of  $Z_{in}$ , then the power  $P_{in}$  is expanded to

$$P_{in} = \frac{1}{2} \left( \frac{Z_{in}}{Z_{in} + Z_0} V_s \cdot \frac{V_s^*}{(Z_{in} + Z_0)^*} + \frac{Z_{in}^*}{(Z_{in} + Z_0)^*} V_s^* \cdot \frac{V_s}{(Z_{in} + Z_0)} \right)$$

- which is easily simplified to (where we have assumed  $Z_0$  is real)

$$P_{in} = \frac{|V_s|^2}{2Z_0} \left( \frac{Z_0 Z_{in} + Z_{in}^* Z_0}{|Z_{in} + Z_0|^2} \right)$$

## Definition of Reflection Coefficient

- With the exception of a factor of 2, the premultiplier is simply the source available power, which means that our overall expression for the reflected power is given by

$$P_r = \frac{V_s^2}{4Z_0} \left( 1 - 2 \frac{Z_0 Z_{in} + Z_{in}^* Z_0}{|Z_{in} + Z_0|^2} \right)$$

which can be simplified

$$P_r = P_{avs} \left| \frac{Z_{in} - Z_0}{Z_{in} + Z_0} \right|^2 = P_{avs} |\Gamma|^2$$

where we have defined  $\Gamma$ , or the reflection coefficient, as

$$\Gamma = \frac{Z_{in} - Z_0}{Z_{in} + Z_0}$$

- From the definition it is clear that  $|\Gamma| \leq 1$ , which is just a re-statement of the conservation of energy implied by our assumption of a passive load.

## Scattering Parameter

- This constant  $\Gamma$ , also called the scattering parameter of a one-port, plays a very important role. On one hand we see that it has a one-to-one relationship with  $Z_{in}$ . Given  $\Gamma$  we can solve for  $Z_{in}$  by inverting the above equation

$$Z_{in} = Z_0 \frac{1 + \Gamma}{1 - \Gamma}$$

which means that all of the information in  $Z_{in}$  is also in  $\Gamma$ . Moreover, since  $|\Gamma| < 1$ , we see that the space of the semi-infinite space of all impedance values with real positive components (the right-half plane) maps into the unit circle. This is a great compression of information which allows us to visualize the entire space of realizable impedance values by simply observing the unit circle. We shall find wide application for this concept when finding the appropriate load/source impedance for an amplifier to meet a given noise or gain specification.

- More importantly,  $\Gamma$  expresses very directly and obviously the power flow in the circuit. If  $\Gamma = 0$ , then the one-port is absorbing all the possible power available from the source. If  $|\Gamma| = 1$  then the one-port is not absorbing any power, but rather “reflecting” the power back to the source. Clearly an open circuit, short circuit, or a reactive load cannot absorb net power. For an open and short load, this is obvious from the definition of  $\Gamma$ . For a reactive load, this is pretty clear if we substitute

$$Z_{in} = jX \quad |\Gamma_X| = \left| \frac{jX - Z_0}{jX + Z_0} \right| = \left| \frac{\sqrt{X^2 + Z_0^2}}{\sqrt{X^2 + Z_0^2}} \right| = 1$$

## Relation between $Z$ and $\Gamma$

- The transformation between impedance and  $\Gamma$  is a well known mathematical transform (see Bilinear Transform). It is a conformal mapping (meaning that it preserves angles) which maps vertical and horizontal lines in the impedance plane into circles. We have already seen that the  $jX$  axis is mapped onto the unit circle. Since  $|\Gamma|^2$  represents power flow, we may imagine that  $\Gamma$  should represent the flow of voltage, current, or some linear combination thereof. Consider taking the square root of the basic equation we have derived

$$\sqrt{P_r} = \Gamma \sqrt{P_{avs}}$$

where we have retained the positive root. We may write the above equation as

$$b_1 = \Gamma a_1$$

where  $a$  and  $b$  have the units of square root of power and represent signal flow in the network. How are  $a$  and  $b$  related to currents and voltage?

## Definition of $a$ and $b$

- Let

$$a_1 = \frac{V_1 + Z_0 I_1}{2\sqrt{Z_0}}$$

and

$$b_1 = \frac{V_1 - Z_0 I_1}{2\sqrt{Z_0}}$$

It is now easy to show that for the one-port circuit, these relations indeed represent the available and reflected power:

$$|a_1|^2 = \frac{|V_1|^2}{4Z_0} + \frac{Z_0|I_1|^2}{4} + \frac{V_1^* \cdot I_1 + V_1 \cdot I_1^*}{4}$$

Now substitute  $V_1 = Z_{in} V_s / (Z_{in} + Z_0)$  and  $I_1 = V_s / (Z_{in} + Z_0)$  we have

$$|a_1|^2 = \frac{|V_s|^2}{4Z_0} \frac{|Z_{in}|^2}{|Z_{in} + Z_0|^2} + \frac{Z_0|V_s|^2}{4|Z_{in} + Z_0|^2} + \frac{|V_s|^2}{4Z_0} \frac{Z_{in}^* Z_0 + Z_{in} Z_0}{|Z_{in} + Z_0|^2}$$

or

$$|a_1|^2 = \frac{|V_s|^2}{4Z_0} \left( \frac{|Z_{in}|^2 + Z_0^2 + Z_{in}^* Z_0 + Z_{in} Z_0}{|Z_{in} + Z_0|^2} \right) = \frac{|V_s|^2}{4Z_0} \left( \frac{|Z_{in} + Z_0|^2}{|Z_{in} + Z_0|^2} \right) = P_{avs}$$



## Relationship between $a/b$ and Power Flow

- In a like manner, the square of  $b$  is given by many similar terms

$$\begin{aligned} |b_1|^2 &= \frac{|V_s|^2}{4Z_0} \left( \frac{|Z_{in}|^2 + Z_0^2 - Z_{in}^* Z_0 - Z_{in} Z_0}{|Z_{in} + Z_0|^2} \right) = P_{avs} \left| \frac{Z_{in} - Z_0}{Z_{in} + Z_0} \right|^2 = P_{avs} |\Gamma|^2 \\ &= |a_1|^2 |\Gamma|^2 \end{aligned}$$

as expected. We can now see that the expression  $b = \Gamma \cdot a$  is analogous to the expression  $V = Z \cdot I$  or  $I = Y \cdot V$  and so it can be generalized to an  $N$ -port circuit. In fact, since  $a$  and  $b$  are linear combinations of  $v$  and  $i$ , there is a one-to-one relationship between the two. Taking the sum and difference of  $a$  and  $b$  we arrive at

$$a_1 + b_1 = \frac{2V_1}{2\sqrt{Z_0}} = \frac{V_1}{\sqrt{Z_0}}$$

which is related to the port voltage and

$$a_1 - b_1 = \frac{2Z_0 I_1}{2\sqrt{Z_0}} = \sqrt{Z_0} I_1$$

which is related to the port current.

# Incident and Scattering Waves

- Let's define the vector  $v^+$  as the incident "forward" waves on each transmission line connected to the  $N$  port. Define the reference plane as the point where the transmission line terminates onto the  $N$  port.
- The vector  $v^-$  is then the reflected or "scattered" waveform at the location of the port.

$$v^+ = \begin{pmatrix} V_1^+ \\ V_2^+ \\ V_3^+ \\ \vdots \end{pmatrix} \qquad v^- = \begin{pmatrix} V_1^- \\ V_2^- \\ V_3^- \\ \vdots \end{pmatrix}$$

- Because the  $N$  port is linear, we expect that scattered field to be a linear function of the incident field

$$v^- = S v^+$$

- $S$  is the scattering matrix

$$S = \begin{pmatrix} S_{11} & S_{12} & \cdots \\ S_{21} & \ddots & \\ \vdots & & \end{pmatrix}$$

## Relation to Voltages

- The fact that the  $S$  matrix exists can be easily proved if we recall that the voltage and current on each transmission line termination can be written as

$$V_i = V_i^+ + V_i^- \qquad I_i = Y_0(I_i^+ - I_i^-)$$

- Inverting these equations

$$V_i + Z_0 I_i = V_i^+ + V_i^- + V_i^+ - V_i^- = 2V_i^+$$

$$V_i - Z_0 I_i = V_i^+ + V_i^- - V_i^+ + V_i^- = 2V_i^-$$

- Thus  $v^+, v^-$  are simply linear combinations of the port voltages and currents. By the uniqueness theorem, then,  $v^- = S v^+$ .

# Measure $S_{ij}$

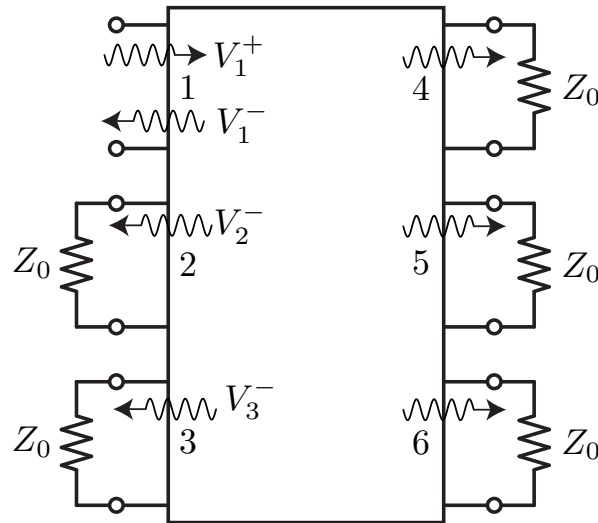

- The term  $S_{ij}$  can be computed directly by the following formula

$$S_{ij} = \left. \frac{V_i^-}{V_j^+} \right|_{V_k^+ = 0 \forall k \neq j}$$

- In other words, to measure  $S_{ij}$ , drive port  $j$  with a wave amplitude of  $V_j^+$  and terminate all other ports with the characteristic impedance of the lines (so that  $V_k^+ = 0$  for  $k \neq j$ ). Then observe the wave amplitude coming out of the port  $i$

## *S* Matrix for a 1-Port Capacitor

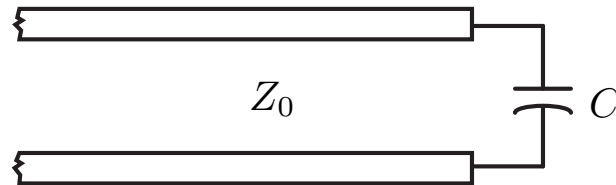

- Let's calculate the  $S$  parameter for a capacitor

$$S_{11} = \frac{V_1^-}{V_1^+}$$

- This is of course just the reflection coefficient for a capacitor

$$\begin{aligned} S_{11} = \rho_L &= \frac{Z_C - Z_0}{Z_C + Z_0} = \frac{\frac{1}{j\omega C} - Z_0}{\frac{1}{j\omega C} + Z_0} \\ &= \frac{1 - j\omega C Z_0}{1 + j\omega C Z_0} \end{aligned}$$

## *S* Matrix for a 1-Port Capacitor (Direct Route)

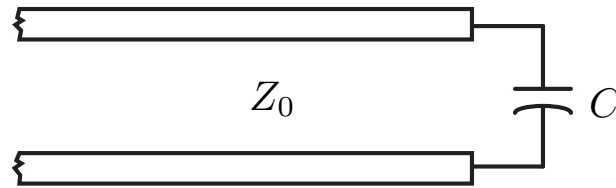

- Let's calculate the  $S$  parameter for a capacitor directly from the definition of  $S$  parameters

$$S_{11} = \frac{V_1^-}{V_1^+}$$

- Substituting for the current in a capacitor

$$V_1^- = V - IZ_0 = V - j\omega CV = V(1 - j\omega CZ_0)$$

$$V_1^+ = V + IZ_0 = V + j\omega CV = V(1 + j\omega CZ_0)$$

- We arrive at the same answer as expected

$$= \frac{1 - j\omega CZ_0}{1 + j\omega CZ_0}$$

## *S Matrix for a 2-Port Shunt Element*

- Consider a shunt impedance connected at the junction of two transmission lines. The voltage at the junction is of course continuous. The currents, though, differ

$$V_1 = V_2$$

$$I_1 + I_2 = Y_L V_2$$

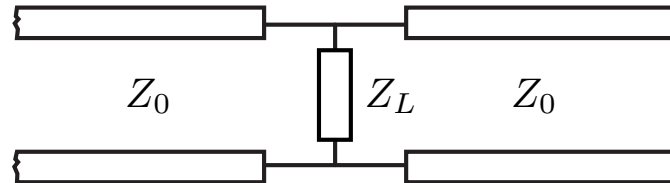

- To compute  $S_{11}$ , enforce  $V_2^+ = 0$  by terminating the line. Thus we can re-write the above equations

$$V_1^+ + V_1^- = V_2^-$$

$$Y_0(V_1^+ - V_1^-) = Y_0 V_2^- + Y_L V_2^- = (Y_L + Y_0)V_2^-$$

- We can now solve the above eq. for the reflected and transmitted wave

$$V_1^- = V_2^- - V_1^+ = \frac{Y_0}{Y_L + Y_0}(V_1^+ - V_1^-) - V_1^+$$

$$V_1^-(Y_L + Y_0 + Y_0) = (Y_0 - (Y_0 + Y_L))V_1^+$$

$$S_{11} = \frac{V_1^-}{V_1^+} = \frac{Y_0 - (Y_0 + Y_L)}{Y_0 + (Y_L + Y_0)} = \frac{Z_0 \parallel Z_L - Z_0}{Z_0 \parallel Z_L + Z_0}$$

## Shunt Element (cont)

- The above eq. can be written by inspection since  $Z_0 || Z_L$  is the effective load seen at the junction of port 1.
- Thus for port 2 we can write

$$S_{22} = \frac{Z_0 || Z_L - Z_0}{Z_0 || Z_L + Z_0}$$

- Likewise, we can solve for the transmitted wave, or the wave scattered into port 2

$$S_{21} = \frac{V_2^-}{V_1^+}$$

- Since  $V_2^- = V_1^+ + V_1^-$ , we have

$$S_{21} = 1 + S_{11} = \frac{2Z_0 || Z_L}{Z_0 || Z_L + Z_0}$$

- By symmetry, we can deduce  $S_{12}$  as

$$S_{12} = \frac{2Z_0 || Z_L}{Z_0 || Z_L + Z_0}$$



## Conversion Formula

- Since  $V^+$  and  $V^-$  are related to  $V$  and  $I$ , it's easy to find a formula to convert for  $Z$  or  $Y$  to  $S$

$$V_i = V_i^+ + V_i^- \rightarrow v = v^+ + v^-$$

$$Z_{i0}I_i = V_i^+ - V_i^- \rightarrow Z_0 i = v^+ - v^-$$

- Now starting with  $v = Zi$ , we have

$$v^+ + v^- = ZZ_0^{-1}(v^+ - v^-)$$

- Note that  $Z_0$  is the scalar port impedance

$$v^-(I + ZZ_0^{-1}) = (ZZ_0^{-1} - I)v^+$$

$$v^- = (I + ZZ_0^{-1})^{-1}(ZZ_0^{-1} - I)v^+ = Sv^+$$

- We now have a formula relating the  $Z$  matrix to the  $S$  matrix

$$S = (ZZ_0^{-1} + I)^{-1}(ZZ_0^{-1} - I) = (Z + Z_0I)^{-1}(Z - Z_0I)$$

## Conversion (cont)

- Recall that the reflection coefficient for a load is given by the same equation!

$$\bar{\rho} = \frac{Z/Z_0 - 1}{Z/Z_0 + 1}$$

- To solve for  $Z$  in terms of  $S$ , simply invert the relation

$$Z_0^{-1} Z S + I S = Z_0^{-1} Z - I$$

$$Z_0^{-1} Z (I - S) = S + I$$

$$Z = Z_0 (I + S) (I - S)^{-1}$$

- As expected, these equations degenerate into the correct form for a  $1 \times 1$  system

$$Z_{11} = Z_0 \frac{1 + S_{11}}{1 - S_{11}}$$

## Reciprocal Networks

- We have found that the  $Z$  and  $Y$  matrix are symmetric. Now let's see what we can infer about the  $S$  matrix.

$$v^+ = \frac{1}{2}(v + Z_0 i)$$

$$v^- = \frac{1}{2}(v - Z_0 i)$$

- Substitute  $v = Zi$  in the above equations

$$v^+ = \frac{1}{2}(Zi + Z_0 i) = \frac{1}{2}(Z + Z_0)i$$

$$v^- = \frac{1}{2}(Zi - Z_0 i) = \frac{1}{2}(Z - Z_0)i$$

- Since  $i = i$ , the above eq. must result in consistent values of  $i$ . Or

$$2(Z + Z_0)^{-1}v^+ = 2(Z - Z_0)^{-1}v^-$$

Thus

$$S = (Z - Z_0)(Z + Z_0)^{-1}$$

## Reciprocal Networks (cont)

- Consider the transpose of the  $S$  matrix

$$S^t = ((Z + Z_0)^{-1})^t (Z - Z_0)^t$$

- Recall that  $Z_0$  is a diagonal matrix

$$S^t = (Z^t + Z_0)^{-1} (Z^t - Z_0)$$

- If  $Z^t = Z$  (reciprocal network), then we have

$$S^t = (Z + Z_0)^{-1} (Z - Z_0)$$

- Previously we found that

$$S = (Z + Z_0)^{-1} (Z - Z_0)$$

- So that we see that the  $S$  matrix is also symmetric (under reciprocity)

$$S^t = S$$

## Another Proof

- Note that in effect we have shown that

$$(Z + I)^{-1}(Z - I) = (Z - I)(Z + I)^{-1}$$

- This is easy to demonstrate if we note that

$$Z^2 - I = Z^2 - I^2 = (Z + I)(Z - I) = (Z - I)(Z + I)$$

- In general matrix multiplication does not commute, but here it does

$$(Z - I) = (Z + I)(Z - I)(Z + I)^{-1}$$

$$(Z + I)^{-1}(Z - I) = (Z - I)(Z + I)^{-1}$$

- Thus we see that  $S^t = S$ .

# Scattering Parameters of a Lossless Network

- Consider the total power dissipated by a network (must sum to zero)

$$P_{av} = \frac{1}{2} \Re (v^t i^*) = 0$$

- Expanding in terms of the wave amplitudes

$$= \frac{1}{2} \Re \left( (v^+ + v^-)^t Z_0^{-1} (v^+ - v^-)^* \right)$$

- Where we assume that  $Z_0$  are real numbers and equal. The notation is about to get ugly

$$= \frac{1}{2Z_0} \Re \left( v^{+t} v^{+*} - v^{+t} v^{-*} + v^{-t} v^{+*} - v^{-t} v^{-*} \right)$$

- Notice that the middle terms sum to a purely imaginary number. Let  $x = v^+$  and  $y = v^-$

$$y^t x^* - x^t y^* = y_1 x_1^* + y_2 x_2^* + \cdots - x_1 y_1^* + x_2 y_2^* + \cdots = a - a^*$$

## Lossless (cont)

- We have shown that

$$P_{av} = \frac{1}{2Z_0} \left( \underbrace{v^{+t} v^+}_{\text{total incident power}} - \underbrace{v^{-t} v^{-*}}_{\text{total reflected power}} \right) = 0$$

- This is a rather obvious result. It simply says that the incident power is equal to the reflected power (because the  $N$  port is lossless). Since  $v^- = Sv^+$

$$v^{+t} v^+ = (Sv^+)^t (Sv^+)^* = v^{+t} S^t S^* v^{+*}$$

- This can only be true if  $S$  is a unitary matrix

$$S^t S^* = I$$

$$S^* = (S^t)^{-1}$$

# Orthogonal Properties of $S$

- Expanding out the matrix product

$$\delta_{ij} = \sum_k (S^T)_{ik} S_{kj}^* = \sum_k S_{ki} S_{kj}^*$$

- For  $i = j$  we have

$$\sum_k S_{ki} S_{ki}^* = 1$$

- For  $i \neq j$  we have

$$\sum_k S_{ki} S_{kj}^* = 0$$

- The dot product of any column of  $S$  with the conjugate of that column is unity while the dot product of any column with the conjugate of a different column is zero. If the network is reciprocal, then  $S^t = S$  and the same applies to the rows of  $S$ .
- Note also that  $|S_{ij}| \leq 1$ .



## Shift in Reference Planes

- Note that if we move the reference planes, we can easily recalculate the  $S$  parameters.
- We'll derive a new matrix  $S'$  related to  $S$ . Let's call the waves at the new reference  $\nu$

$$v^- = Sv^+$$

$$\nu^- = S'\nu^+$$

- Since the waves on the lossless transmission lines only experience a phase shift, we have a phase shift of  $\theta_i = \beta_i \ell_i$

$$\nu_i^- = v^- e^{-j\theta_i}$$

$$\nu_i^+ = v^+ e^{j\theta_i}$$

## Reference Plane (cont)

- Or we have

$$\begin{bmatrix} e^{j\theta_1} & 0 & \dots & \\ 0 & e^{j\theta_2} & \dots & \\ 0 & 0 & e^{j\theta_3} & \dots \\ \vdots & & & \end{bmatrix} \nu^- = S \begin{bmatrix} e^{-j\theta_1} & 0 & \dots & \\ 0 & e^{-j\theta_2} & \dots & \\ 0 & 0 & e^{-j\theta_3} & \dots \\ \vdots & & & \end{bmatrix} \nu^+$$

- So we see that the new  $S$  matrix is simply

$$S' = \begin{bmatrix} e^{-j\theta_1} & 0 & \dots & \\ 0 & e^{-j\theta_2} & \dots & \\ 0 & 0 & e^{-j\theta_3} & \dots \\ \vdots & & & \end{bmatrix} S \begin{bmatrix} e^{-j\theta_1} & 0 & \dots & \\ 0 & e^{-j\theta_2} & \dots & \\ 0 & 0 & e^{-j\theta_3} & \dots \\ \vdots & & & \end{bmatrix}$$

## Normalized S-Parameters

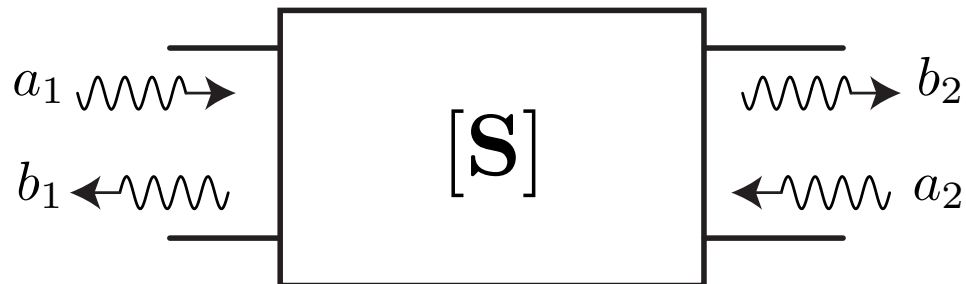

- Let's introduce normalized voltage waves

$$a(x) = \frac{v^+(x)}{\sqrt{Z_0}} \qquad b(x) = \frac{v^-(x)}{\sqrt{Z_0}}$$

- So now  $|a|^2$  and  $|b|^2$  represent the power of the forward and reverse wave.
- Define the scattering matrix as before

$$b = Sa$$

- For a  $2 \times 2$  system, this is simply

$$\begin{bmatrix} b_1 \\ b_2 \end{bmatrix} = \begin{bmatrix} S_{11} & S_{12} \\ S_{21} & S_{22} \end{bmatrix} \begin{bmatrix} a_1 \\ a_2 \end{bmatrix}$$

# Generalized Scattering Parameters

- We can use different impedances  $Z_{0,n}$  at each port and so we have the generalized incident and reflected waves

$$a_n = \frac{v_n^+}{\sqrt{Z_{0,n}}} \qquad b_n = \frac{v_n^-}{\sqrt{Z_{0,n}}}$$

- The scattering parameters are now given by

$$S_{ij} = \left. \frac{b_i}{a_j} \right|_{a_{k \neq j} = 0} \qquad S_{ij} = \left. \frac{V_i^-}{V_j^+} \frac{\sqrt{Z_{0,j}}}{\sqrt{Z_{0,i}}} \right|_{V_{k \neq j}^+ = 0}$$

- Consider the current and voltage in terms of  $a$  and  $b$

$$V_n = v_n^+ + v_n^- = \sqrt{Z_{0,n}}(a_n + b_n) \qquad I_n = \frac{1}{Z_{0,n}}(v_n^- - v_n^+) = \frac{1}{\sqrt{Z_{0,n}}}(a_n - b_n)$$

- The power flowing into this port is given by

$$P_n = \frac{1}{2} \Re(V_n I_n^*) = \frac{1}{2} \Re(|a_n|^2 - |b_n|^2 + (b_n a_n^* - b_n^* a_n))$$

- Observe that the last term is purely imaginary so we have

$$P_n = \frac{1}{2} (|a_n|^2 - |b_n|^2)$$

# Scattering Transfer Parameters

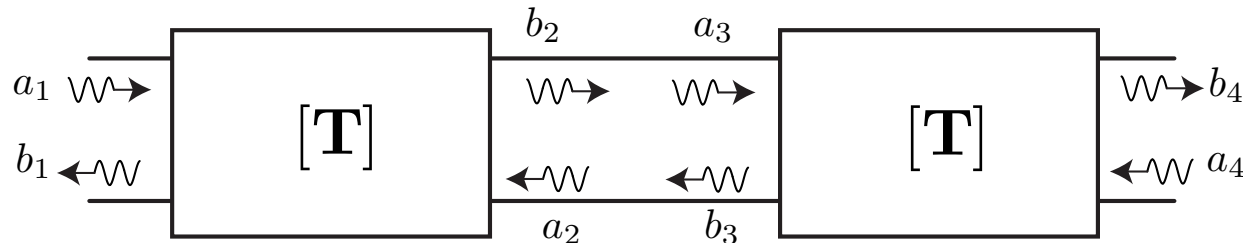

- Up to now we found it convenient to represent the scattered waves in terms of the incident waves. But what if we wish to cascade two ports as shown?
- Since  $b_2$  flows into  $a_3$ , and likewise  $b_3$  flows into  $a_2$ , would it not be convenient if we defined the a relationship between  $a_1, b_1$  and  $b_2, a_2$ ?
- In other words we have

$$\begin{bmatrix} a_1 \\ b_1 \end{bmatrix} = \begin{bmatrix} T_{11} & T_{12} \\ T_{21} & T_{22} \end{bmatrix} \begin{bmatrix} b_2 \\ a_2 \end{bmatrix}$$

- Notice carefully the order of waves ( $a, b$ ) in reference to the figure above. This allows us to cascade matrices

$$\begin{bmatrix} a_1 \\ b_1 \end{bmatrix} = T_1 \begin{bmatrix} b_2 \\ a_2 \end{bmatrix} = T_1 \begin{bmatrix} a_3 \\ b_3 \end{bmatrix} = T_1 T_2 \begin{bmatrix} b_4 \\ a_4 \end{bmatrix}$$

## Representation of Source

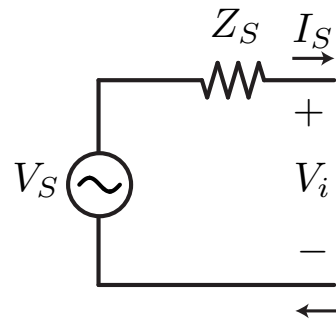

$$V_i = V_s - I_s Z_s$$

- The voltage source can be represented directly for s-parameter analysis as follows. First note that

$$V_i^+ + V_i^- = V_s + \left( \frac{V_i^+}{Z_0} - \frac{V_i^-}{Z_0} \right) Z_s$$

- Solve these equations for  $V_i^-$ , the power flowing away from the source

$$V_i^- = V_i^+ \frac{Z_s - Z_0}{Z_s + Z_0} + \frac{Z_0}{Z_0 + Z_s} V_s$$

- Dividing each term by  $\sqrt{Z_0}$ , we have

$$\frac{V_i^-}{\sqrt{Z_0}} = \frac{V_i^+}{\sqrt{Z_0}} \Gamma_s + \frac{\sqrt{Z_0}}{Z_0 + Z_s} V_s \quad b_i = a_i \Gamma_s + b_s \quad b_s = V_s \sqrt{Z_0} / (Z_0 + Z_s)$$

## Available Power from Source

- A useful quantity is the available power from a source under conjugate matched conditions. Since

$$P_{avs} = |b_i|^2 - |a_i|^2$$

- If we let  $\Gamma_L = \Gamma_S^*$ , then using  $a_i = \Gamma_L b_i$ , we have

$$b_i = b_s + a_i \Gamma_S = b_s + \Gamma_S^* b_i \Gamma_S$$

- Solving for  $b_i$  we have

$$b_i = \frac{b_s}{1 - |\Gamma_S|^2}$$

- So the  $P_{avs}$  is given by

$$\begin{aligned} P_{avs} &= |b_i|^2 - |a_i|^2 = |b_s|^2 \left( \frac{1 - |\Gamma_S|^2}{(1 - |\Gamma_S|^2)^2} \right) \\ &= \frac{|b_s|^2}{1 - |\Gamma_S|^2} \end{aligned}$$

# Signal-Flow Analysis

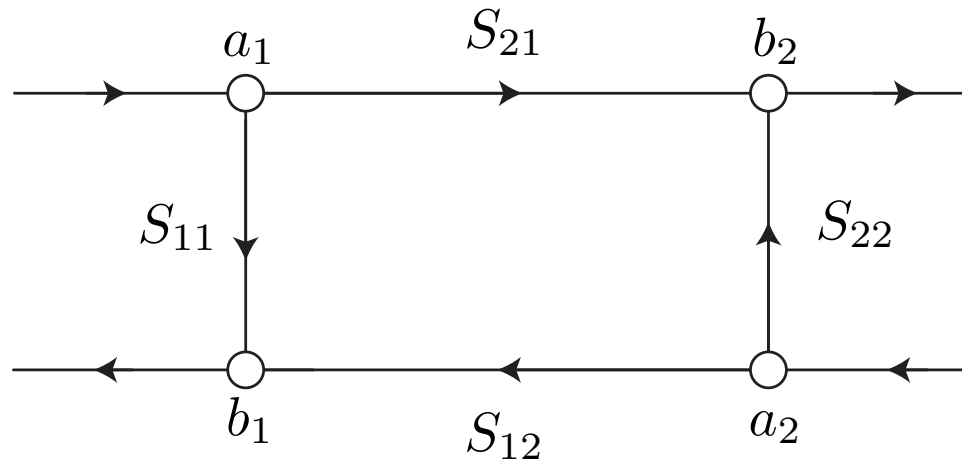

- Each signal  $a$  and  $b$  in the system is represented by a node. Branches connect nodes with “strength” given by the scattering parameter. For example, a general two-port is represented above.
- Using three simple rules, we can simplify signal flow graphs to the point that detailed calculations are done by inspection. Of course we can always “do the math” using algebra, so pick the technique that you like best.



# Series and Parallel Rules

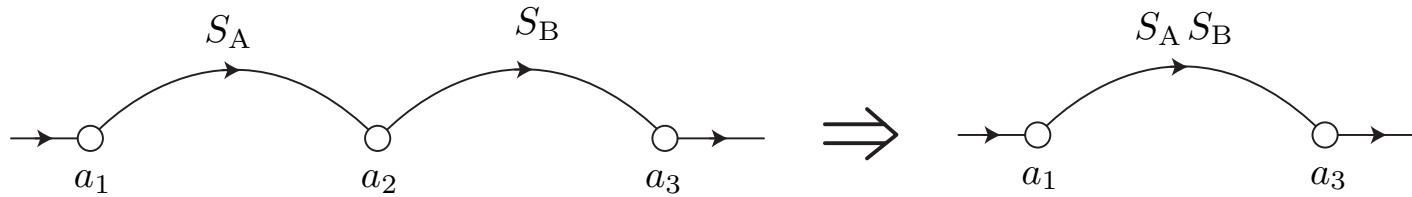

- Rule 1: (series rule) By inspection, we have the cascade.

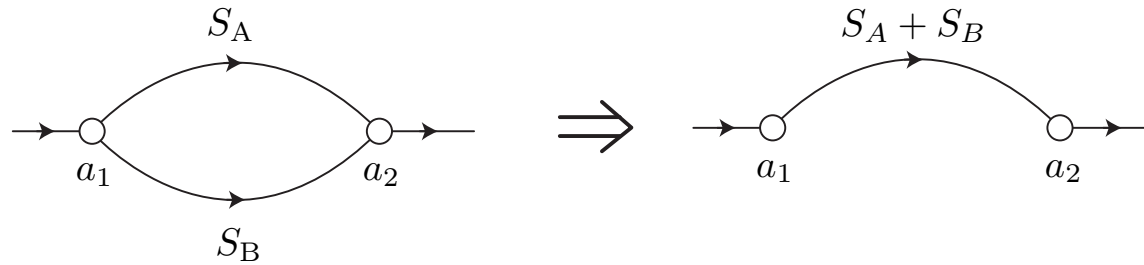

- Rule 2: (parallel rule) Clear by inspection.

# Self-Loop Rule

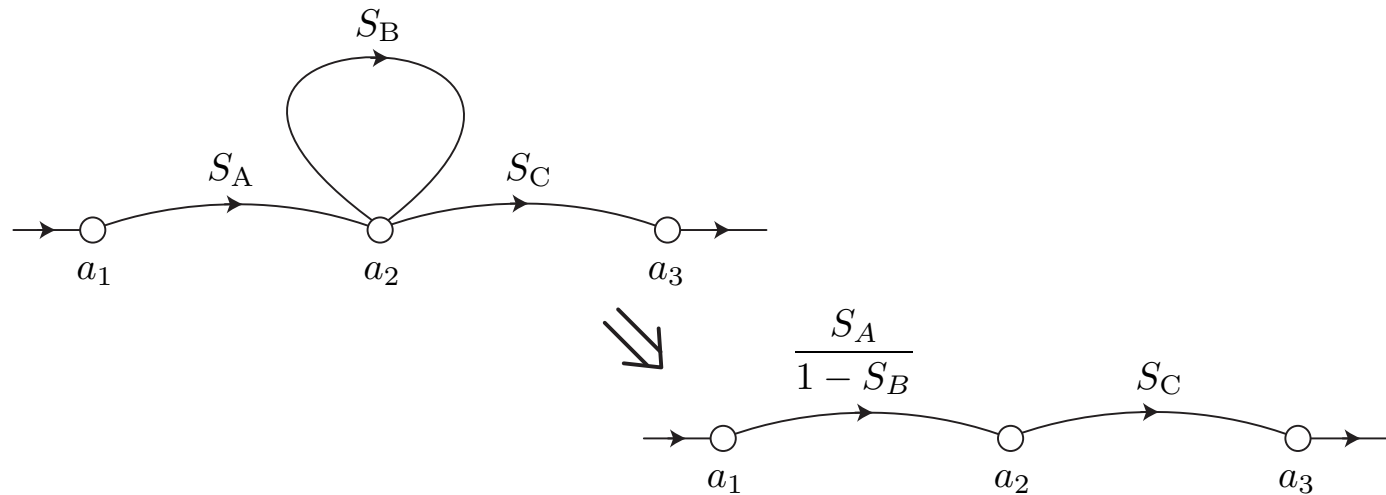

- Rule 3: (self-loop rule) We can remove a “self-loop” by multiplying branches feeding the node by  $1/(1 - S_B)$  since

$$a_2 = S_A a_1 + S_B a_2$$

$$a_2(1 - S_B) = S_A a_1$$

$$a_2 = \frac{S_A}{1 - S_B} a_1$$

# Splitting Rule

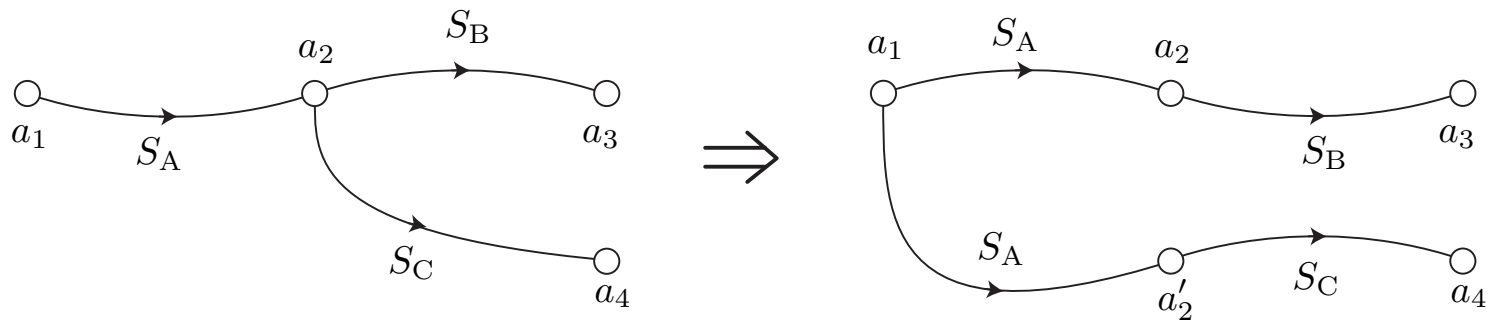

- We can duplicate node  $a_2$  by splitting the signals at an earlier phase

## Signal Flow Analysis Example

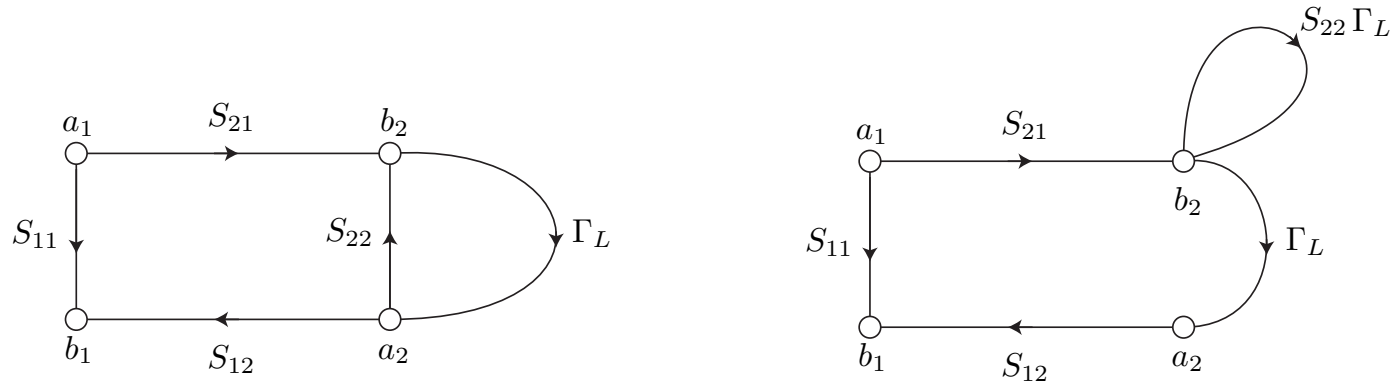

- Using the above rules, we can calculate the input reflection coefficient of a two-port terminated by  $\Gamma_L = b_1/a_1$  using a couple of steps.
- First we notice that there is a self-loop around  $b_2$ .

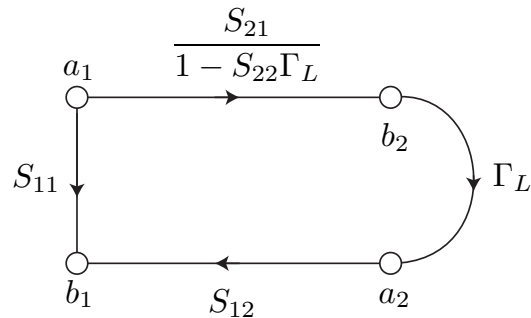

- Next we remove the self loop and from here it's clear that the

$$\Gamma_{in} = \frac{b_1}{a_1} = S_{11} + \frac{S_{21}S_{12}\Gamma_L}{1 - S_{22}\Gamma_L}$$

# Mason's Rule

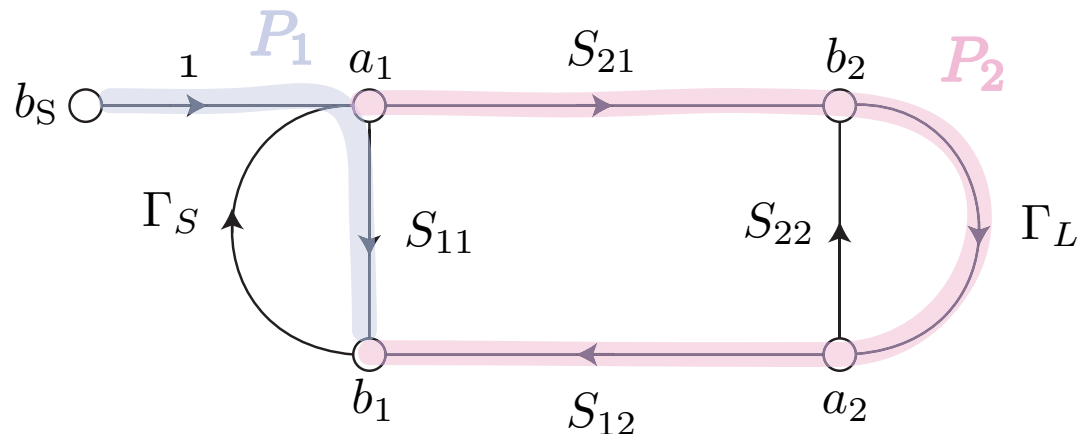

- Using Mason's Rule, you can calculate the transfer function for a signal flow graph by "inspection"

$$T = \frac{P_1 (1 - \sum \mathcal{L}(1)^{(1)} + \sum \mathcal{L}(2)^{(1)} - \dots) + P_2 (1 - \sum \mathcal{L}(1)^{(2)} + \dots) + \dots}{1 - \sum \mathcal{L}(1) + \sum \mathcal{L}(2) - \sum \mathcal{L}(3) + \dots}$$

- Each  $P_i$  defines a *path*, a directed route from the input to the output not containing each node more than once. The value of  $P_i$  is the product of the branch coefficients along the path.
- For instance the path from  $b_s$  to  $b_1$  ( $T = b_1/b_s$ ) has two paths,  $P_1 = S_{11}$  and  $P_2 = S_{21}\Gamma_L S_{12}$

## Loop of Order Summation Notation

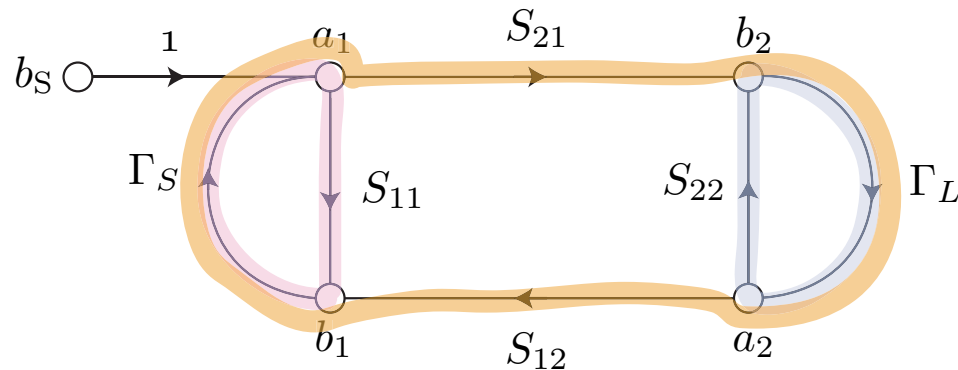

- The notation  $\sum \mathcal{L}(1)$  is the sum over all first order loops.
- A “first order loop” is defined as product of the branch values in a loop in the graph. For the given example we have  $\Gamma_s S_{11}$ ,  $S_{22} \Gamma_L$ , and  $\Gamma_s S_{21} \Gamma_L S_{12}$ .
- A “second order loop”  $\mathcal{L}(2)$  is the product of two non-touching first-order loops. For instance, since loops  $S_{11} \Gamma_s$  and  $S_{22} \Gamma_L$  do not touch, their product is a second order loop.
- A “third order loop”  $\mathcal{L}(3)$  is likewise the product of three non-touching first order loops.
- The notation  $\sum \mathcal{L}(1)^{(p)}$  is the sum of all first-order loops that do not touch the path  $p$ .
- For path  $P_1$ , we have  $\sum \mathcal{L}(1)^{(1)} = \Gamma_L S_{22}$  but for path  $P_2$  we have  $\sum \mathcal{L}(1)^{(2)} = 0$ .

## Example: Input Reflection of Two-Port

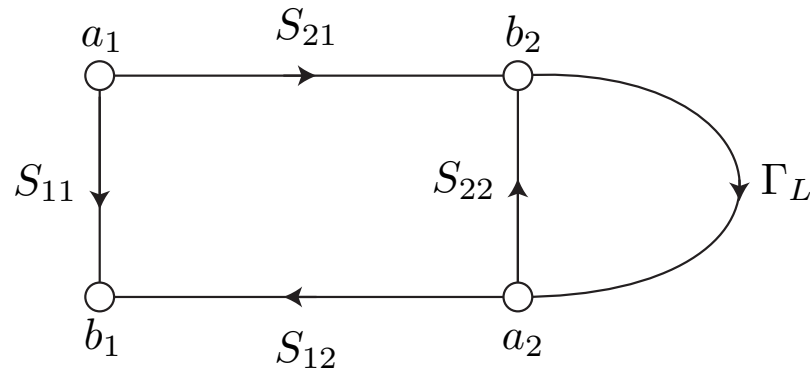

- Using Mason's rule, you can quickly identify the relevant paths for a  $\Gamma_{in} = b_1/a_1$ .
- There are two paths  $P_1 = S_{11}$  and  $P_2 = S_{21}\Gamma_L S_{12}$
- There is only one first-order loop:  $\sum \mathcal{L}(1) = S_{22}\Gamma_L$  and so naturally there are no higher order loops.
- Note that the loop does not touch path  $P_1$ , so  $\sum \mathcal{L}(1)^{(1)} = S_{22}\Gamma_L$ .
- Now let's apply Mason's general formula

$$\Gamma_{in} = \frac{S_{11}(1 - S_{22}\Gamma_L) + S_{21}\Gamma_L S_{12}}{1 - S_{22}\Gamma_L} = S_{11} + \frac{S_{21}\Gamma_L S_{12}}{1 - S_{22}\Gamma_L}$$

## Example: Transducer Power Gain

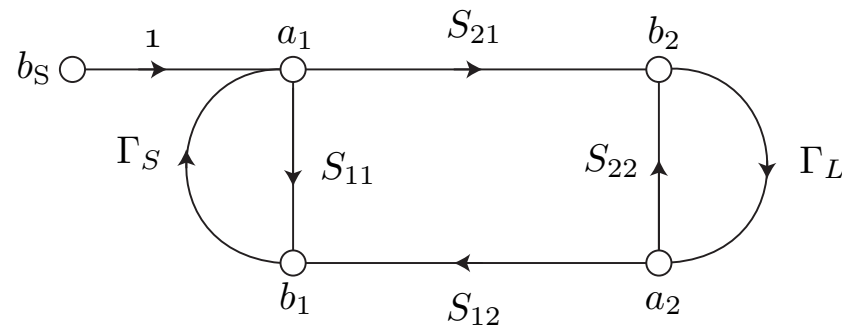

- By definition, the transducer power gain is given by

$$G_T = \frac{P_L}{P_{AVS}} = \frac{|b_2|^2(1 - |\Gamma_L|^2)}{\frac{|b_S|^2}{1 - |\Gamma_S|^2}}$$

$$= \left| \frac{b_2}{b_S} \right|^2 (1 - |\Gamma_L|^2)(1 - |\Gamma_S|^2)$$

- By Mason's Rule, there is only one path  $P_1 = S_{21}$  from  $b_S$  to  $b_2$  so we have

$$\sum \mathcal{L}(1) = \Gamma_S S_{11} + S_{22} \Gamma_L + \Gamma_S S_{21} \Gamma_L S_{12}$$

$$\sum \mathcal{L}(2) = \Gamma_S S_{11} \Gamma_L S_{22}$$

$$\sum \mathcal{L}(1)^{(1)} = 0$$



## Transducer Gain (cont)

- The gain expression is thus given by

$$\frac{b_2}{b_S} = \frac{S_{21}(1 - 0)}{1 - \Gamma_S S_{11} - S_{22}\Gamma_L - \Gamma_S S_{21}\Gamma_L S_{12} + \Gamma_S S_{11}\Gamma_L S_{22}}$$

- The denominator is in the form of  $1 - x - y + xy$  which allows us to write

$$G_T = \frac{|S_{21}|^2(1 - |\Gamma_S|^2)(1 - |\Gamma_L|^2)}{|(1 - S_{11}\Gamma_S)(1 - S_{22}\Gamma_L) - S_{21}S_{12}\Gamma_L\Gamma_S|^2}$$

- Recall that  $\Gamma_{in} = S_{11} + S_{21}S_{12}\Gamma_L/(1 - S_{22}\Gamma_L)$ . Factoring out  $1 - S_{22}\Gamma_L$  from the denominator we have

$$\text{den} = \left(1 - S_{11}\Gamma_S - \frac{S_{21}S_{12}\Gamma_L}{1 - S_{22}\Gamma_L}\Gamma_S\right) (1 - S_{22}\Gamma_L)$$

$$\begin{aligned}\text{den} &= \left(1 - \Gamma_S \left(S_{11} + \frac{S_{21}S_{12}\Gamma_L}{1 - S_{22}\Gamma_L}\right)\right) (1 - S_{22}\Gamma_L) \\ &= (1 - \Gamma_S\Gamma_{in})(1 - S_{22}\Gamma_L)\end{aligned}$$

# Transducer Gain Expression

- This simplifications allows us to write the transducer gain in the following convenient form

$$G_T = \frac{1 - |\Gamma_S|^2}{|1 - \Gamma_{in}\Gamma_S|^2} |S_{21}|^2 \frac{1 - |\Gamma_L|^2}{|1 - S_{22}\Gamma_L|^2}$$

- Which can be viewed as a product of the action of the input match “gain”, the intrinsic two-port gain  $|S_{21}|^2$ , and the output match “gain”. Since the general two-port is not unilateral, the input match is a function of the load.
- Likewise, by symmetry we can also factor the expression to obtain

$$G_T = \frac{1 - |\Gamma_S|^2}{|1 - S_{11}\Gamma_S|^2} |S_{21}|^2 \frac{1 - |\Gamma_L|^2}{|1 - \Gamma_{out}\Gamma_L|^2}$$

# Refs

- “S Parameter Design,” *Hewlett-Packard Application Note 154*, April 1972.
- *Microwave Transistor Amplifiers, Analysis and Design*, Guillermo Gonzalez, Prentice Hall 1984.
- *Microwave Engineering*, David Pozer, Third Edition, Wiley 2005.
- *Microwave Circuit Design Using Linear and Nonlinear Techniques*, by George Vendelin, Anthony M. Pavio, & Ulrich L. Rohde, Wiley 1995.